



# FAX ORDER FORM PLANT STANDS

www.detailretail.com.au

**FAX TO: 03 9555 0335**  
**P: 03 9555 3351**

## DELIVERY

## PAYMENT METHOD

## TOTAL

BUSINESS NAME: .....

ADDRESS: .....

PHONE: .....

CONTACT NAME: .....

DELIVERY INSTRUCTIONS: .....

CHEQUE, MONEY ORDER  
POST TO: detail retail, Factory 20, 94 Keys Rd  
Moorabbin VIC 3189

PLEASE NOTE:  
100% payment required on order  
please make cheques payable  
to: detail retail

BANK DEPOSIT  
Direct payment to account  
National Australia Bank Account: 083-323 54-476-1588

100% payment required on order

CREDIT CARD  VISA  MASTERCARD  BANKCARD

CARD HOLDER NAME .....

CARD NO. ....

EXPIRY DATE: .....

CARDHOLDER  
SIGNATURE: .....

AMOUNT: .....

SUBTOTAL

\$

DELIVERY

\$

GST

\$

TOTAL

\$

### LARGE THREE TIER

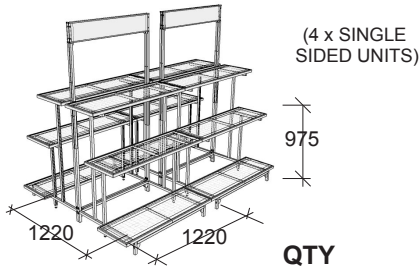

QTY

### MEDIUM THREE TIER

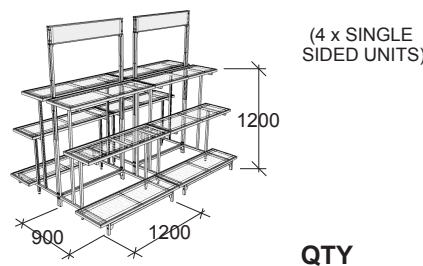

QTY

### SEEDLING STAND

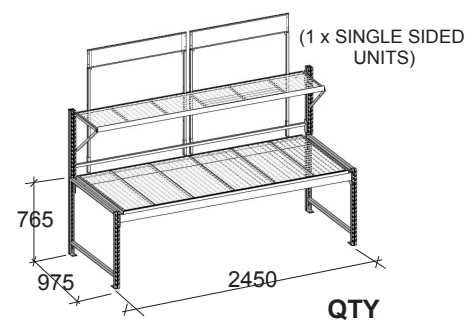

QTY

\$1045+gst

\$1045+gst

\$595+gst

HANGING BASKET RAIL  
\$59+gst

HANGING BASKET RAIL  
\$59+gst

### LARGE HALF ROUND

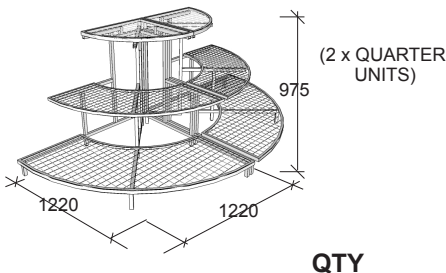

QTY

### MEDIUM THREE TIER

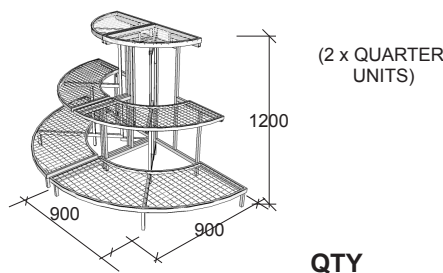

QTY

### TROLLEY



QTY

\$495+gst

\$495+gst

\$375+gst

### MOBILE PLANT STAND



QTY

\$650+gst

### ROUND TABLES

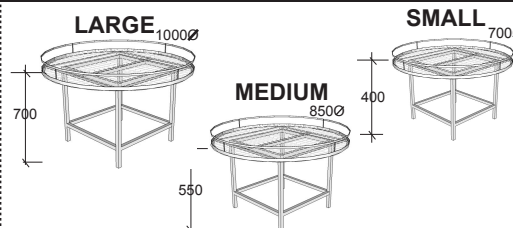

QTY

POWDERCOATING

LARGE  
\$235+gst

LARGE  
\$63+gst

MEDIUM  
\$195+gst

MEDIUM  
\$52+gst

SMALL  
\$175+gst

SMALL  
\$42+gst

CASTORS \$15per set

### RECTANGULAR TABLE

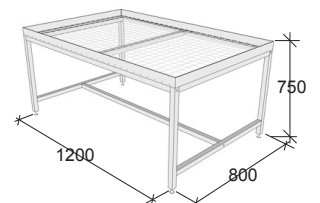

QTY

\$265+gst

CASTORS \$15per set